

MODE™**CLICK®**
ScolmoreGROUP

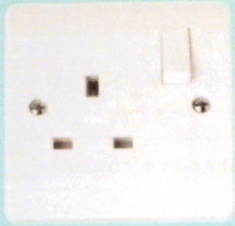

Power Socket Outlets



The smooth modern lines of the MODE accessory plate will fit easily into traditional and contemporary designs alike.

All MODE 13A sockets are tested and approved to BS1363 offering assured quality and safety through our BSI Kitemark Licence KM10807.

Scolmore International Ltd, 1 Scolmore Park, Landsberg, Lichfield Road Ind. Estate, Tamworth, Staffordshire, B79 7XB
Telephone: 01827 63454
E-mail: sales@scolmore.com, technical@scolmore.com
Facsimile: 01827 63362
Website: www.scolmore.com



13A UK Socket Outlets

Product Range

13A UK Socket Outlets

CMA030	13A 1 Gang Socket Outlet
CMA032	13A 1 Gang Socket Outlet (Twin Earth)
CMA035	13A 1 Gang DP Switched Socket Outlet
CMA036	13A 2 Gang DP Switched Socket Outlet (Twin Earth)
CMA037	13A 2 Gang DP Switched Socket Outlet (Twin Earth, Clean Earth)
CMA630	13A 1 Gang Socket Outlet (Twin Earth)
CMA635	13A 1 Gang DP Switched Socket Outlet (Twin Earth)

13A UK Socket Outlets (Outboard Rockers)

CMA836	13A 2 Gang DP OB Switched Socket Outlet (Twin Earth)
CMA840	13A 2 Gang DP OB Switched Socket Outlet & Neons (Twin Earth)

13A UK Socket Outlets (Red Rockers)

CMA035PWRD	13A 1 Gang DP Switched Socket Outlet (Twin Earth)
CMA836PWRD	13A 2 Gang DP Outboard Switched Socket Outlet (Twin Earth)

13A UK Locating Plug Socket Outlets

CMA735	13A 1 Gang DP Switched Locating Plug Socket Outlet
CMA736	13A 2 Gang DP Outboard Switched Locating Plug Socket Outlet (Twin Earth)

Errors & Omissions excluded. Specification is subject to change without notice.

V1.0

Scolmore International Ltd, 1 Scolmore Park, Landsberg, Lichfield Road Ind. Estate, Tamworth, Staffordshire, B79 7XB

Telephone: 01827 63454

E-mail: sales@scolmore.com, technical@scolmore.com

Facsimile: 01827 63362

Website: www.scolmore.com

MODE™ **CLICK®**
ScolmoreGROUP

13A UK Socket Outlets

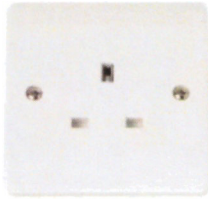

CMA030, CMA630



CMA035, CMA635

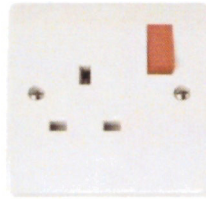

CMA035PWRD

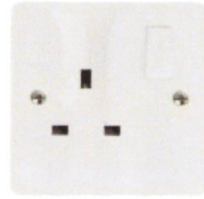

CMA735



CMA032

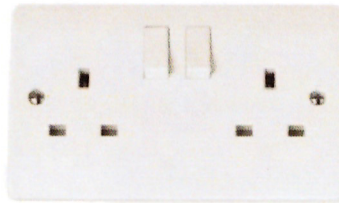

CMA036, CMA037

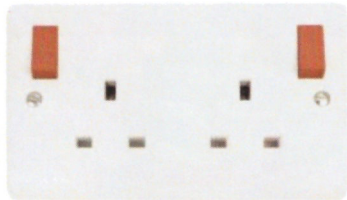

CMA836PWRD

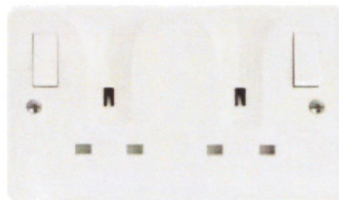

CMA736

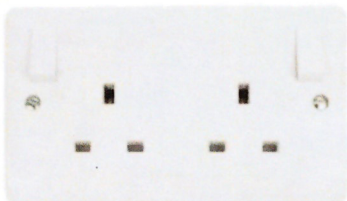

CMA836



CMA840

Errors & Omissions excluded. Specification is subject to change without notice

V1.0

Scolmore International Ltd, 1 Scolmore Park, Landsberg, Lichfield Road Ind. Estate, Tamworth, Staffordshire, B79 7XB

Telephone: 01827 63454

Facsimile: 01827 63362

E-mail: sales@scolmore.com, technical@scolmore.com

Website: www.scolmore.com



13A UK Socket Outlets

Product Dimensional Drawings (mm)

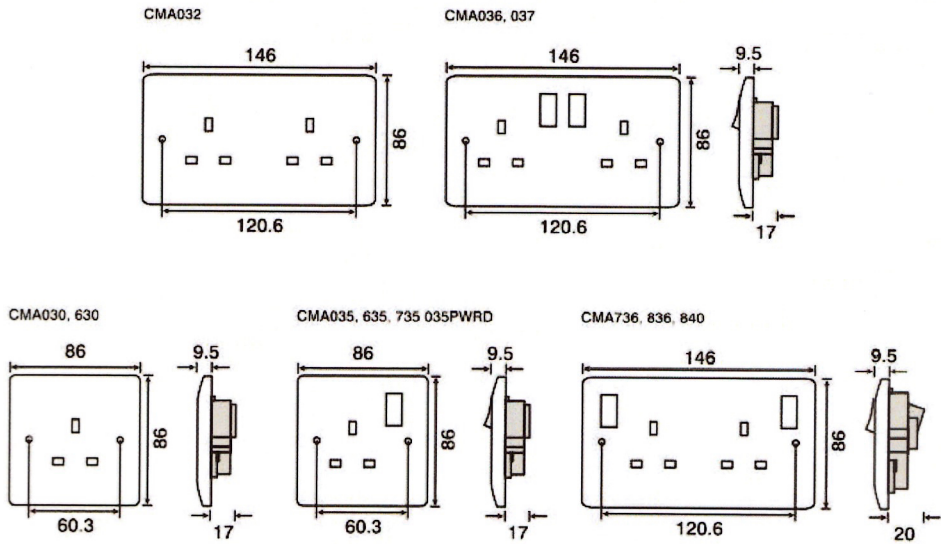

Product Wiring Diagram

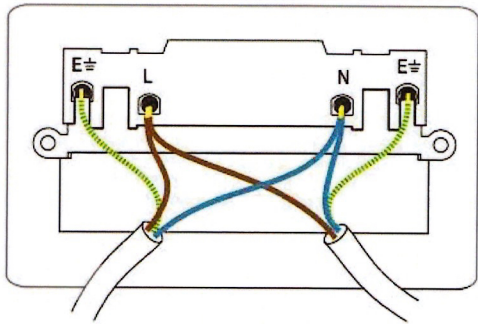

Errors & Omissions excluded. Specification is subject to change without notice.

V1.0

Scolmore International Ltd, 1 Scolmore Park, Landsberg, Lichfield Road Ind. Estate, Tamworth, Staffordshire, B79 7XB
Telephone: 01827 63454 **Facsimile:** 01827 63362
E-mail: sales@scolmore.com, technical@scolmore.com **Website:** www.scolmore.com

MODE™

CLICK®
ScolmoreGROUP

13A UK Socket Outlets

Technical Specification

13A UK Socket Outlets

Material Composition	Front Plate, Rocker Switch & Rear Housing: Urea Terminals: Brass Terminal Screws: Steel & Yellow Passivated Internal Mechanism: Formed Press Brass Silver "on-lay" Copper / Brass Contacts
Voltage	240V – 50Hz
Current Rating	13A
Terminal Size	5mm ø
Torque Value	2.5Nm
Cable Size	4 x 2.5mm ²
Back Box Depth	25mm - 47mm
Double Pole Switched	(035, 035PWRD, 036, 037, 635, 735, 736 836, 836PWRD 840)
Twin Earth	(036, 037, 630, 635, 736, 836, 836PWRD, 840)
Warranty	20 Years
Anti Microbial Certified	Yes
IP Rating	IP20
Operational Temperature	-5° to +40°C
Standards	KM10807 Kitemark Licence BS 1363-2:1995+A4:2012 Modified ISO 22196

Additional Information

Ensure that the mains supply is isolated before commencing installation and refer to the circuit diagram with the relevant product.

Bare earth cables must always be covered with appropriate sleeving and wired to the earth terminal.

All white moulded accessories are manufactured using Urea Formaldehyde, which has similar inherent properties to antimicrobial additives that inhibit the growth of infectious diseases. All products were independently tested and achieved a 99.9% kill rate across all four types of the strains of bacteria - MRSA, E-Coli, Salmonella, and Klebsiella Pneumoniae.

Errors & Omissions excluded. Specification is subject to change without notice.

V1.0

Scolmore International Ltd, 1 Scolmore Park, Landsberg, Lichfield Road Ind. Estate, Tamworth, Staffordshire, B79 7XB

Telephone: 01827 63454

E-mail: sales@scolmore.com, technical@scolmore.com

Facsimile: 01827 63362

Website: www.scolmore.com

CLICK MODE

Scolmore
GROUP

Scolmore International Ltd
1 Scolmore Park, Landsberg
Lichfield Road Industrial Estate
Tamworth, Staffordshire B79 7XB

t: 01827 63454
f: 01827 63362
e: sales@scolmore.com
w: www.scolmore.com

DECLARATION OF CONFORMITY

1. **Issuer Name** Scolmore International Limited
2. **Issuer Address** 1 Scolmore Park, Landsberg,
Lichfield Road Industrial Estate,
Tamworth, Staffordshire, B79 7XB
3. **Object(s) of Declaration** Mode Range
 - a. **Group** Socket Outlets
 - b. **Model No.** CMA030, CMA032, CMA035, CMA036, CMA037, CMA630, CMA635,
CMA735, CMA736, CMA836, CMA840, CMA035PWRD, CMA836PWRD,
CMA935, CMA936
4. *The object of the declaration described above is in conformity with the requirements of the following Legislations:*
5. *All products contained within the aforementioned comply with the relevant standards and requirements listed below.*

BSI Kitemark Licence KM10807
BS 1363-2: 1995 + A4: 2012

6. *I hereby declare that the equipment named above has been designed to comply with the relevant sections of the above referenced specifications. The unit complies with all applicable Essential Requirements of the Directives.*

In conjunction with the above all manufacture and process controls are in accordance with ISO 9001:2008

Signed, for and on behalf of: Scolmore International Limited



Steven Bettson BSc - Senior Technical Support Engineer

CE 13



Company Registration No: 2513009

CLICK OVA